

Electrical Specifications ( $T_A = +25^\circ\text{C}$ )

Parameter	Specification	Unit
Suitable Frequency	0.2-0.4	GHz
Relative Bandwidth	10%	-
Insertion Loss	$\leq 0.5$	dB
Isolation	$\geq 18$	dB
VSWR	$\leq 1.3:1$	--
Operating Temperature	0 to +60	$^\circ\text{C}$
Load Power	/	W
Connector Type	TAB	

Outline Drawing

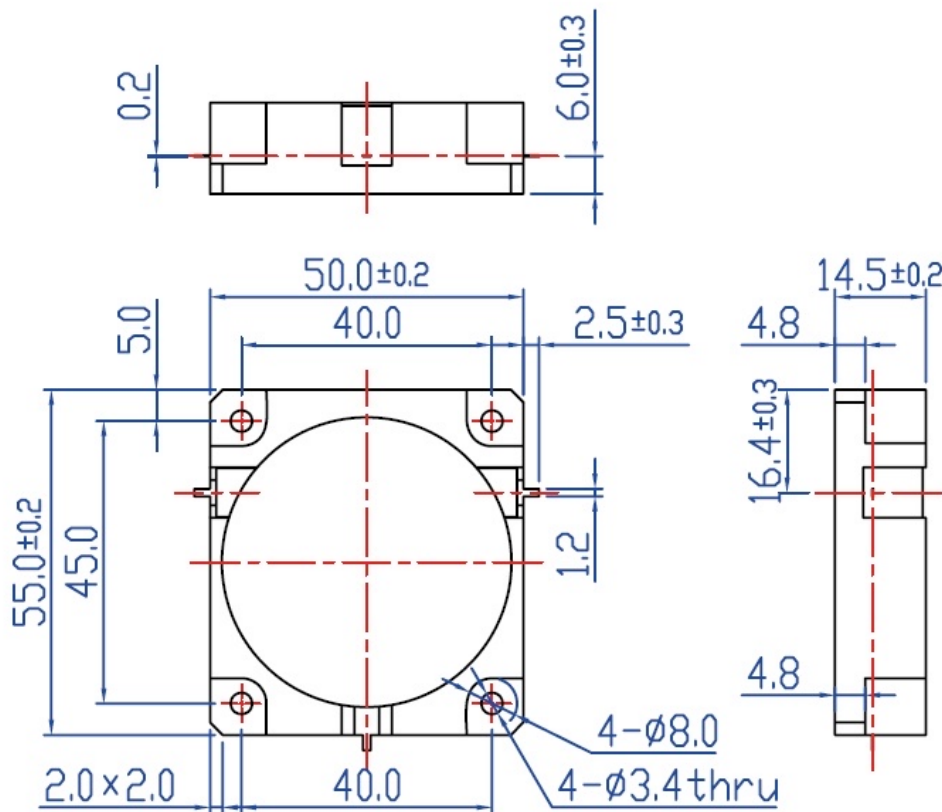

Unit: mm