

Electrical Specifications ($T_A = +25^\circ\text{C}$)

Parameter	Specification	Unit
Suitable Frequency	0.8-2.2	GHz
Relative Bandwidth	5%	-
Insertion Loss	≤ 0.4	dB
Isolation	≥ 23	dB
VSWR	$\leq 1.2:1$	--
Operating Temperature	-40 to +85	$^\circ\text{C}$
Load Power	10	W
Connector Type	TAB	

Outline Drawing

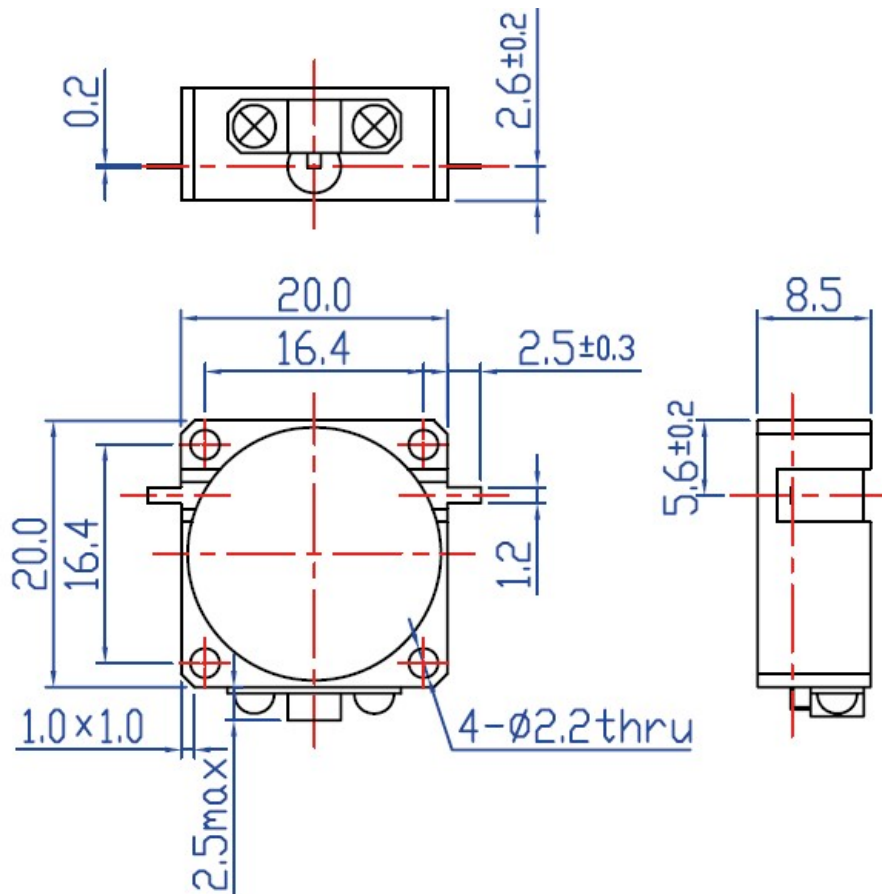

Unit: mm