

Electrical Specifications ($T_A = +25^\circ\text{C}$)

| Parameter | Specification | Unit |
|-----------------------|-------------------|------|
| Frequency | 1930-1990 | MHz |
| IMD | -70 | dBc |
| IMD Test Requirements | 2×43dBm, 5MHz gap | - |
| Insertion Loss | ≤0.3 | dB |
| Isolation | ≥21 | dB |
| VSWR | ≤1.2:1 | -- |
| Operating Temperature | -40 to +85 | °C |
| Load Power | 100 | W |
| Connector Type | TAB | |

Outline Drawing

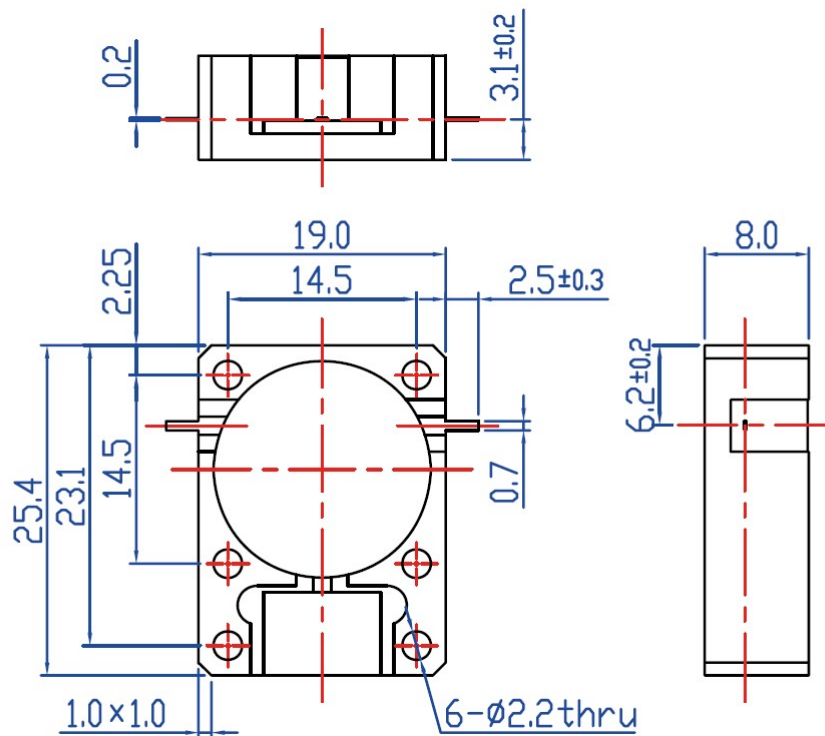

Unit: mm