

Electrical Specifications ($T_A = +25^\circ\text{C}$)

Parameter	Specification	Unit
Frequency	2110-2170	MHz
IMD	-75	dBc
IMD Test Requirements	2×45dBm, 5MHz gap	-
Insertion Loss	≤0.25	dB
Isolation	≥23	dB
VSWR	≤1.2:1	--
Operating Temperature	-40 to +85	°C
Load Power	/	W
Connector Type	TAB	

Outline Drawing

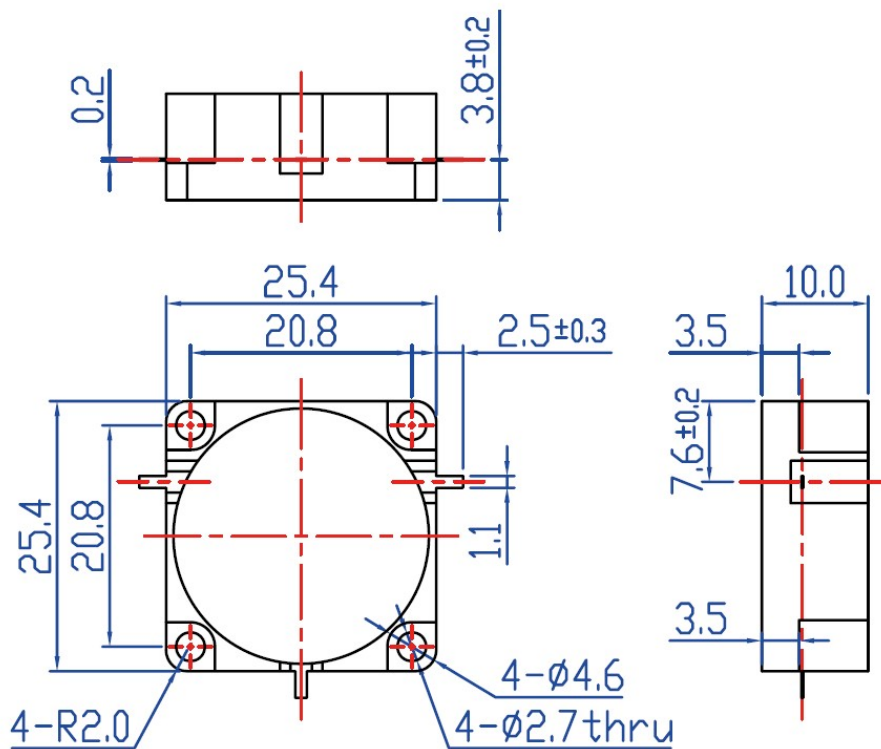

Unit: mm