

**Electrical Specifications** ( $T_A = +25^\circ\text{C}$ )

Parameter	Specification	Unit
Frequency	8.5-10.5	GHz
Insertion Loss	$\leq 0.5$	dB
Isolation	$\geq 18$	dB
VSWR	$\leq 1.3:1$	--
Operating Temperature	-55 to +85	$^\circ\text{C}$
Load Power	0.5	W
Connector Type	GWB	

**Outline Drawing**

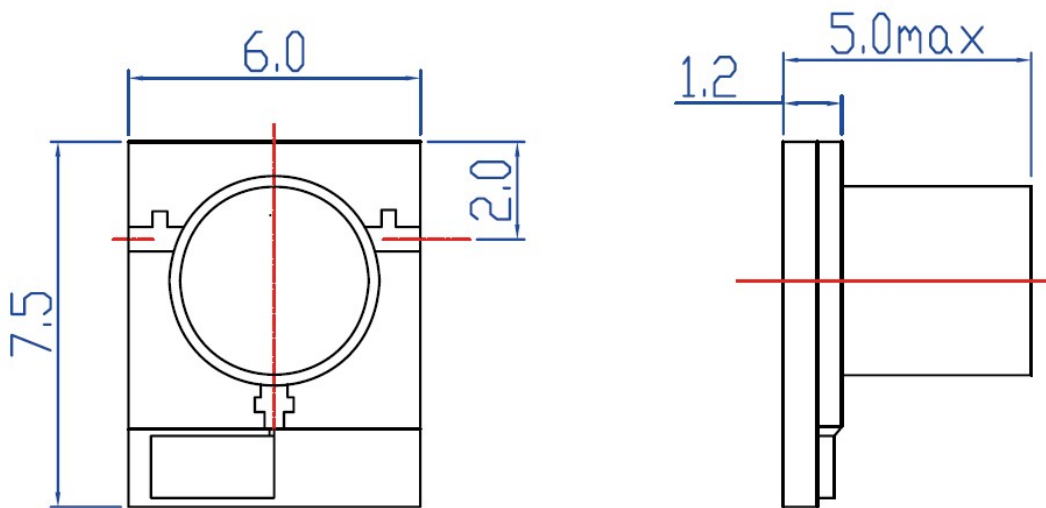

Unit: mm