

Electrical Specifications ($T_A = +25^\circ\text{C}$)

Parameter	Specification	Unit
Frequency	8-12	GHz
Insertion Loss	$\leq 0.6(2 \rightarrow 1)$	dB
	$\leq 1.2(3 \rightarrow 2)$	
Isolation	$\geq 16(1 \rightarrow 3)$	dB
	$\geq 30(2 \rightarrow 3)$	
VSWR	$\leq 1.3:1$	--
Operating Temperature	-55 to +85	$^\circ\text{C}$
Load Power	20	W
Connector Type	GWB	

Outline Drawing

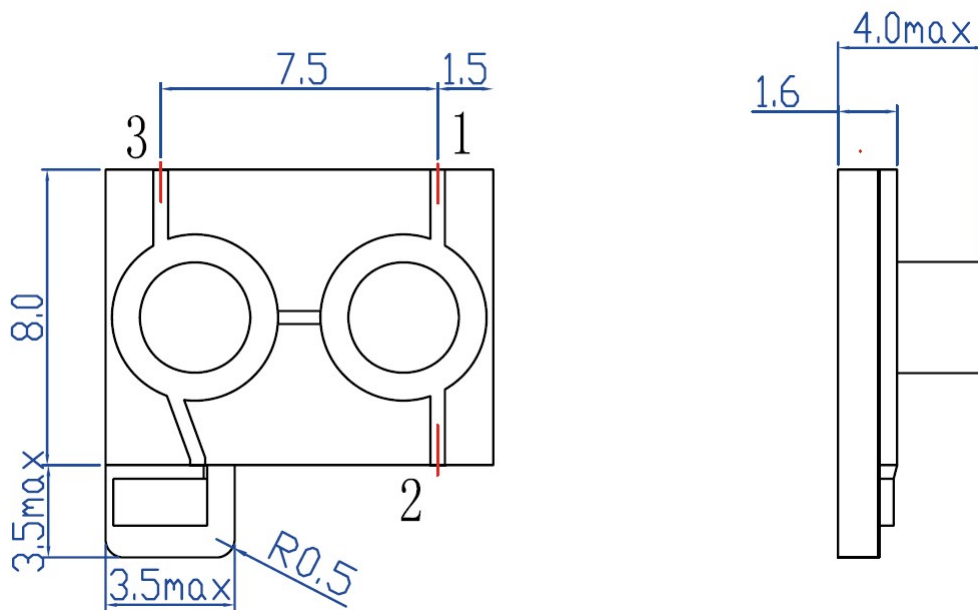

Unit: mm