

Electrical Specifications ($T_A = +25^\circ\text{C}$)

Parameter	Specification	Unit
Frequency	32-36	GHz
Insertion Loss	≤ 1.3	dB
Isolation	≥ 15	dB
VSWR	$\leq 1.5:1$	--
Operating Temperature	-55 to +85	$^\circ\text{C}$
Load Power	0.5	W
Connector Type	GWB	

Outline Drawing

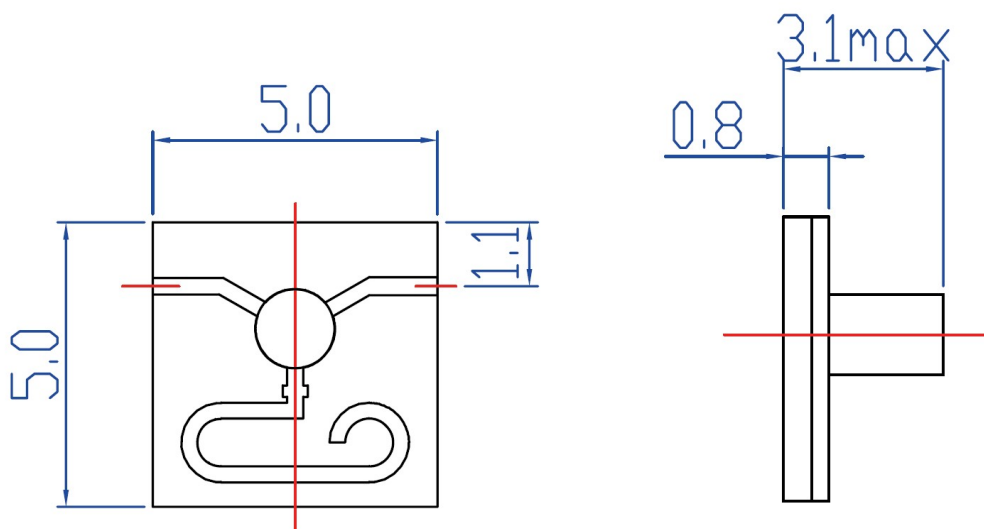

Unit: mm