

**Electrical Specifications** ( $T_A = +25^\circ\text{C}$ )

Parameter	Specification	Unit
Frequency	5.1-5.7	GHz
Insertion Loss	$\leq 0.5(2 \rightarrow 3)$	dB
	$\leq 1.0(3 \rightarrow 1)$	
Isolation	$\geq 20(3 \rightarrow 2)$	dB
	$\geq 38(1 \rightarrow 3)$	
VSWR	$\leq 1.3:1$	--
Operating Temperature	-55 to +85	$^\circ\text{C}$
Load Power	10	W
Connector Type	GWB	

**Outline Drawing**

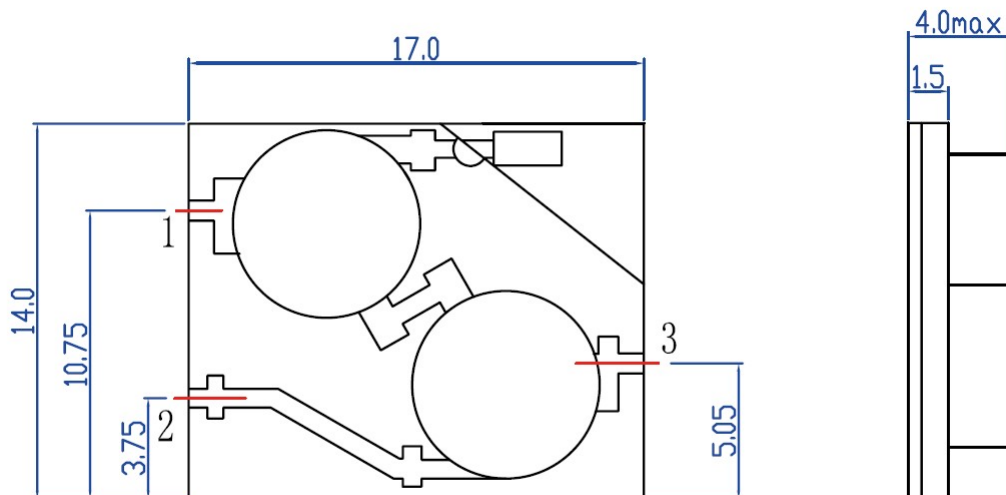

Unit: mm