

Electrical Specifications ($T_A = +25^\circ\text{C}$)

Parameter	Specification	Unit
Frequency	5.2-5.9	GHz
Insertion Loss	≤ 0.5	dB
Isolation	≥ 18	dB
VSWR	$\leq 1.3:1$	--
Operating Temperature	-55 to +85	$^\circ\text{C}$
Load Power	/	W
Connector Type	GWB	

Outline Drawing

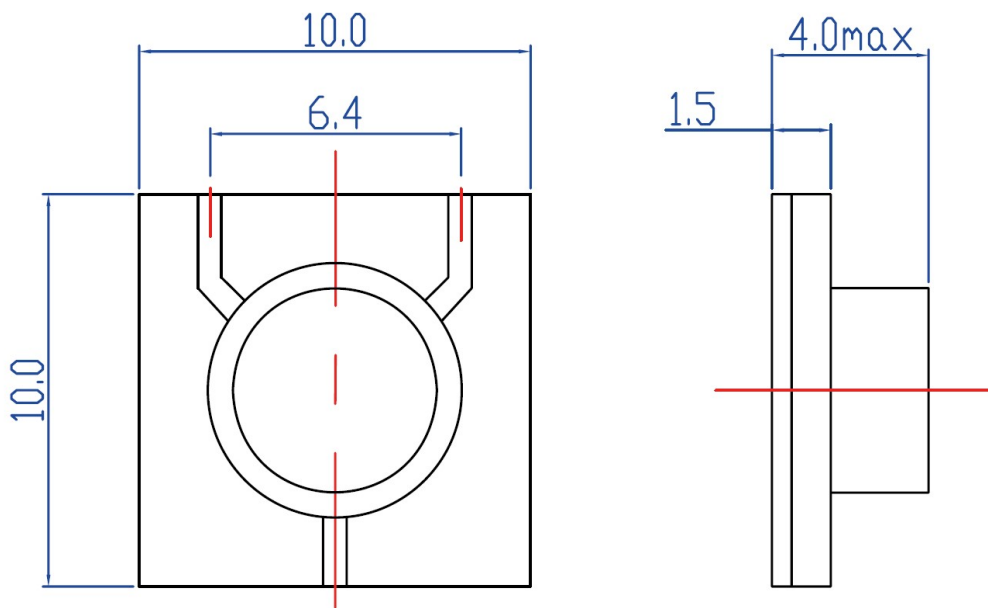

Unit: mm