

**Description: NMD3.5mm Female To NMD3.5mm Female Adapter**

**Outline drawing:**

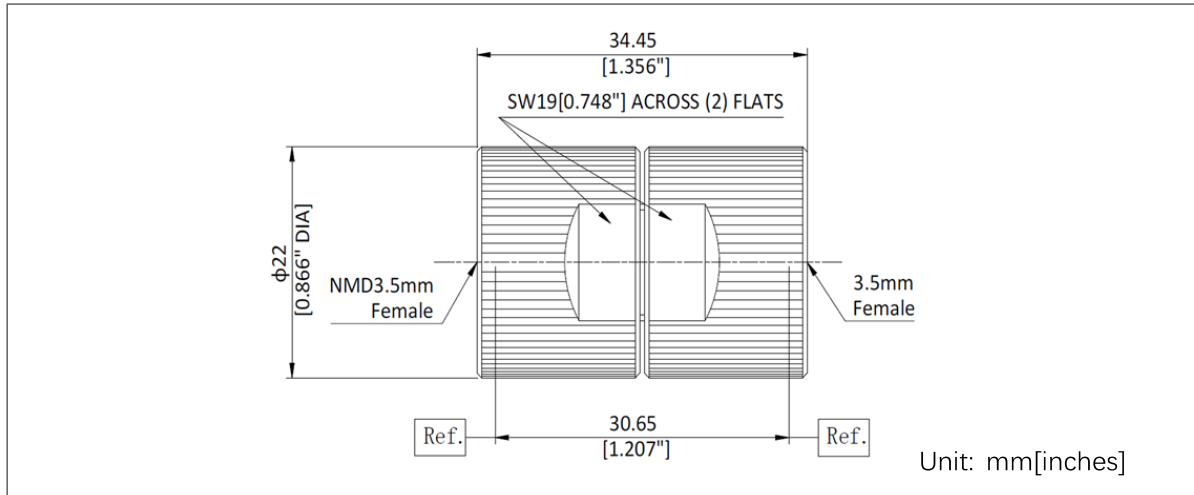

**Type**

	Connector 1	Connector 2
Port Type	NMD3.5mm Female	NMD3.5mm Female
Impedance	50Ω	50Ω
Body Style	Straight	

**Material and Plating**

Body	SUS303, Polished & Passivated
Center conductor	Beryllium Copper Gold Plated
Dielectric	PEEK

**Electrical Specifications**

Frequency Range	DC-26.5GHz
Max VSWR	1.15:1(max)

**Mechanical Specifications**

	Connector 1	Connector 2
Durability	> 2000 Cycles	> 2000 Cycles
Recommended Torque	0.9 Nm	0.9 Nm

**Environmental Data**

Operating Temperature Range	-55~+165°C
2002/95/EC(RoHS)	Compliant