

**Description: 2.4mm Male To 2.4mm Female Adapter**

**Outline drawing:**

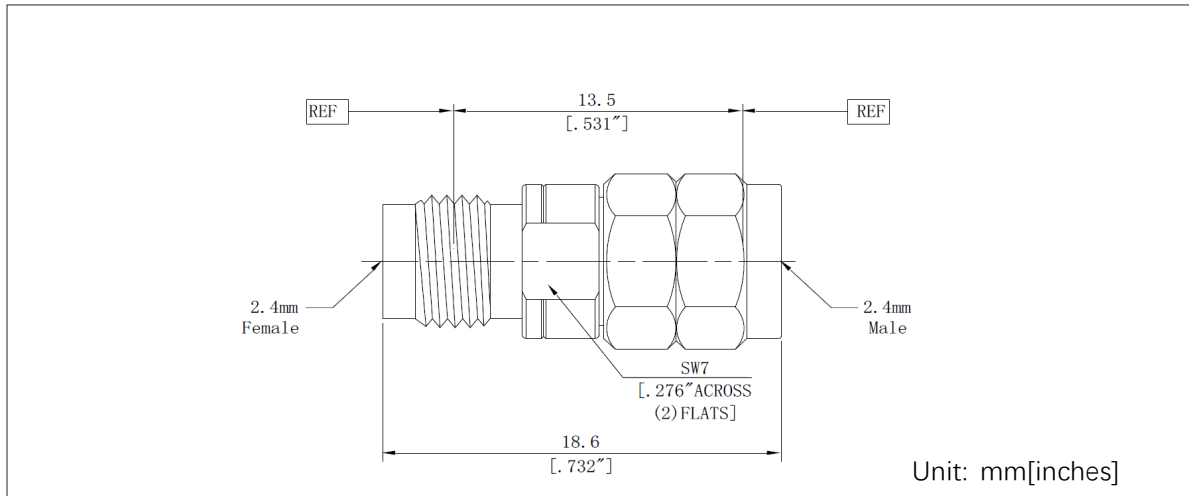

**Type**

	Connector 1	Connector 2
Port Type	2.4mm Male	2.4mm Female
Impedance	50Ω	50Ω
Body Style	Straight	

**Material and Plating**

Body	SUS303, Polished & Passivated
Center conductor	Beryllium Copper Gold Plated
Dielectric	PEI
Nut	Connector 1: SUS303, Polished & Passivated; Connector 2: N/A

**Electrical Specifications**

Frequency Range	DC-50GHz
Max VSWR	1.15:1(max)

**Mechanical Specifications**

	Connector 1	Connector 2
Durability	> 2000 Cycles	> 2000 Cycles
Recommended Torque	0.9 Nm	0.9 Nm

**Environmental Data**

Operating Temperature Range	-55~+165°C
2002/95/EC(RoHS)	Compliant