

Description: 2.4mm Female To 2.4mm Female Adapter

Outline drawing:

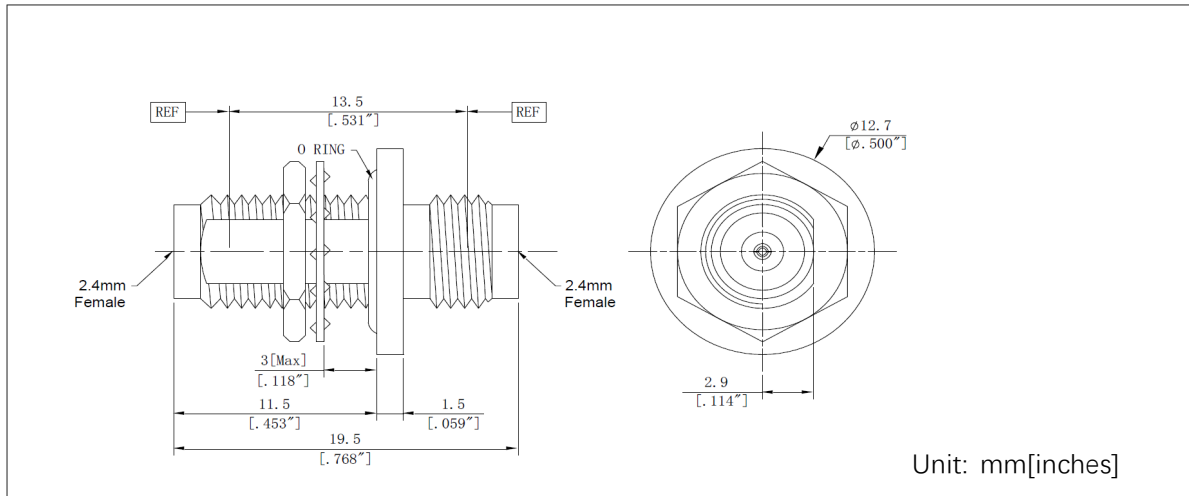

Type

	Connector 1	Connector 2
Port Type	2.4mm Female	2.4mm Female
Impedance	50Ω	50Ω
Body Style	Straight, Bulkhead Mount	

Material and Plating

Body	SUS303, Polished & Passivated
Center conductor	Beryllium Copper Gold Plated
Dielectric	PEI

Electrical Specifications

Frequency Range	DC-50GHz
Max VSWR	1.20:1(max)

Mechanical Specifications

	Connector 1	Connector 2
Durability	> 2000 Cycles	> 2000 Cycles
Recommended Torque	0.9 Nm	0.9 Nm

Environmental Data

Operating Temperature Range	-55~+165°C
2002/95/EC(RoHS)	Compliant