

**Description: NMD2.92mm Female To NMD2.92mm Male Adapter**

**Outline drawing:**

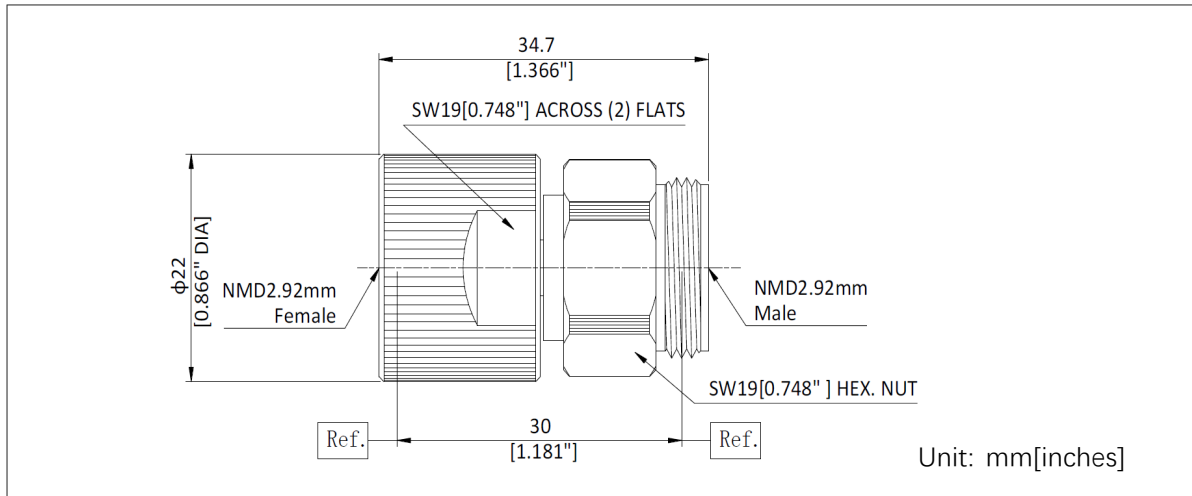

**Type**

	Connector 1	Connector 2
Port Type	NMD2.92mm Female	NMD2.92mm Male
Impedance	50Ω	50Ω
Body Style	Straight	

**Material and Plating**

Body	SUS303, Polished & Passivated
Center conductor	Beryllium Copper Gold Plated
Dielectric	PEEK
Nut	Connector 1: N/A; Connector 2: SUS303, Polished & Passivated

**Electrical Specifications**

Frequency Range	DC-40GHz
Max VSWR	1.20:1(max)

**Mechanical Specifications**

	Connector 1	Connector 2
Durability	> 2000 Cycles	> 2000 Cycles
Recommended Torque	0.9 Nm	0.9 Nm

**Environmental Data**

Operating Temperature Range	-55~+165°C
2002/95/EC(RoHS)	Compliant