

Description: 3.5mm Male To SMA Female Adapter

Outline drawing:

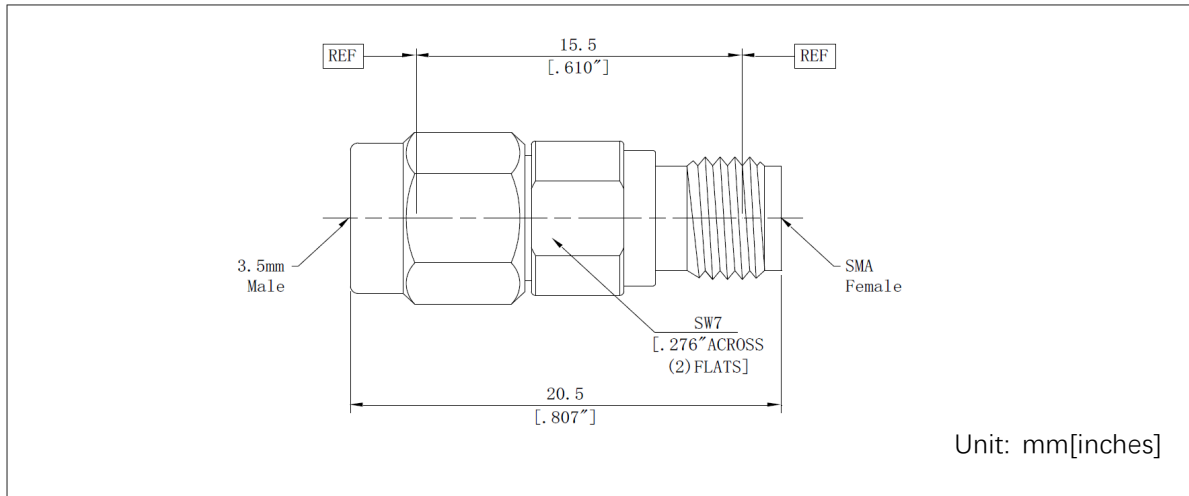

Type

	Connector 1	Connector 2
Port Type	3.5mm Male	SMA Female
Impedance	50Ω	50Ω
Body Style	Straight	

Material and Plating

Body	SUS303, Polished & Passivated
Center conductor	Beryllium Copper Gold Plated
Dielectric	PEI&PTFE
Nut	Connector 1: SUS303, Polished & Passivated; Connector 2: N/A

Electrical Specifications

Frequency Range	DC-26.5GHz
Max VSWR	1.15:1(max)

Mechanical Specifications

	Connector 1	Connector 2
Durability	> 2000 Cycles	> 2000 Cycles
Recommended Torque	0.9 Nm	0.9 Nm

Environmental Data

Operating Temperature Range	-55~+165°C
2002/95/EC(RoHS)	Compliant