

Features

Ultra Wide Band

Low Insertion Loss

High Isolation

Rush Delivery

Fast Response

Customization Available Upon Request

Electrical Specifications

Parameter		Min.	Typ.	Max.	Unit
Frequency		2	-	8	GHz
Insertion Loss		-	0.5	0.6	dB
Isolation		20	22	-	dB
Input VSWR		-	-	1.3	--
Output VSWR		-	-	1.2	--
Amplitude Unbalance		-	-	±0.3	dB
Phase Unbalance		-	-	±3	deg
Power Rating	Forward Power	30			W
	Reverse Power	2			W
Impedance		50			Ohms
Weight		0.88			Ounce
Input / Output Connectors		SMA-FEMALE			
Finish		Black Paint			

Environmental Specifications

Operating Temperature	-45 to +85°C
Storage Temperature	-55 to +125°C
Altitude	30,000ft (Epoxy Sealed Controlled environment)
Vibration	25g RMS (15 degrees 2KHz) endurance, 1 hour per axis
Humidity	100% RH at 35°C 95% RH at 40°C
Shock	20G for 11msec half sinewave, 3 axis both directions

Outline Drawing

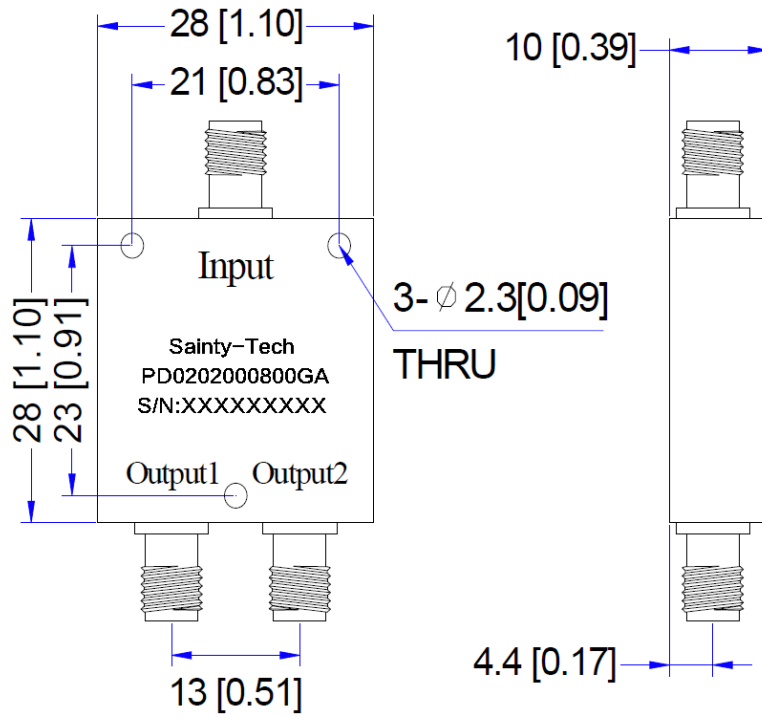

Unit: mm [inches]

Outline tolerance: ± 0.2 [0.008]