

Performance

- Frequency: 32~38GHz
- Typical Signal Gain: 24dB
- Typical Pout: 39dBm@24V
- Typical PAE: 28%
- Typical Operating Current: 1.5A
- Bias: 24V, -1.8/-2V
- Technology: 0.15um HEMT
- Size: 3.6*2mm*0.05mm

Function Diagram

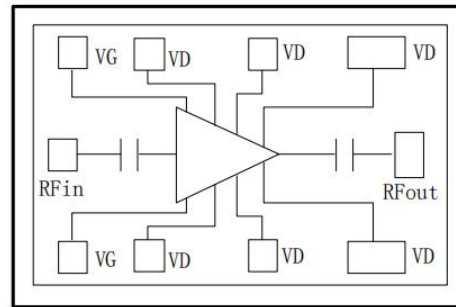

Electrical Specifications (TA=25°C, Vd=24V, Vg= -2V, F:32~38GHz)

Symbol	Parameter	Min	Typical	Max	Unit
G	Small Signal Gain	-	24	-	dB
Gp	Power Gain	-	15	-	dB
Pout	Saturated Power	-	39	-	dBm
Id	Dynamic Current	-	1.5	-	A

Test Curves

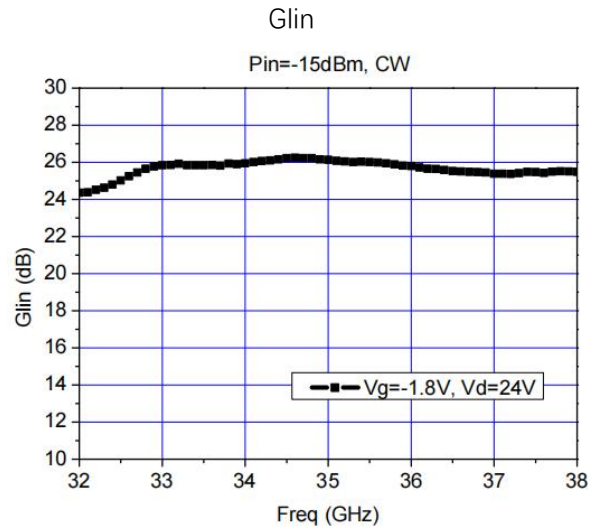
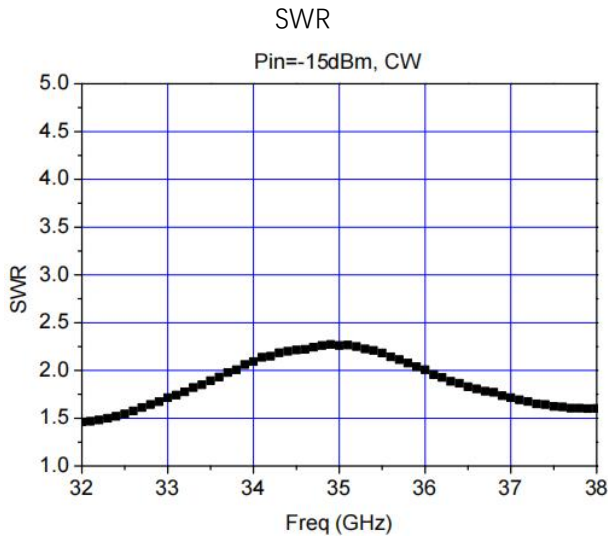

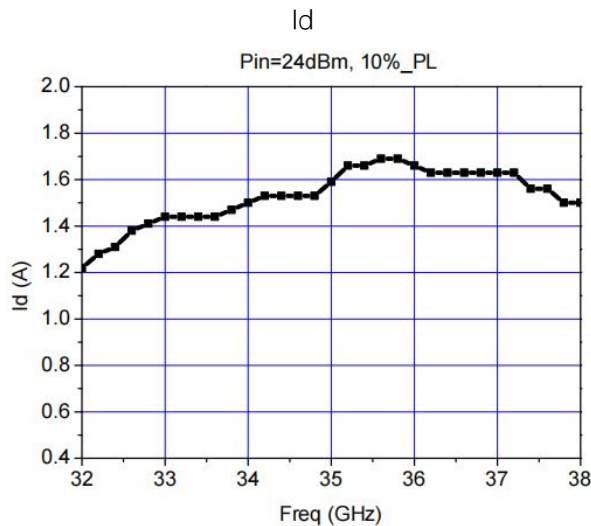
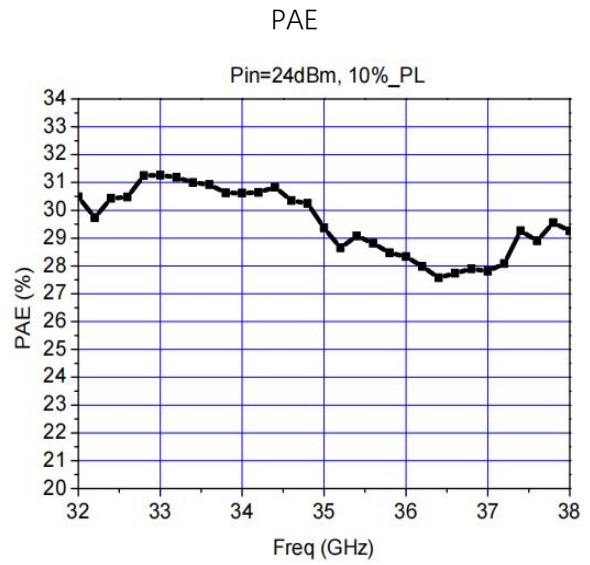
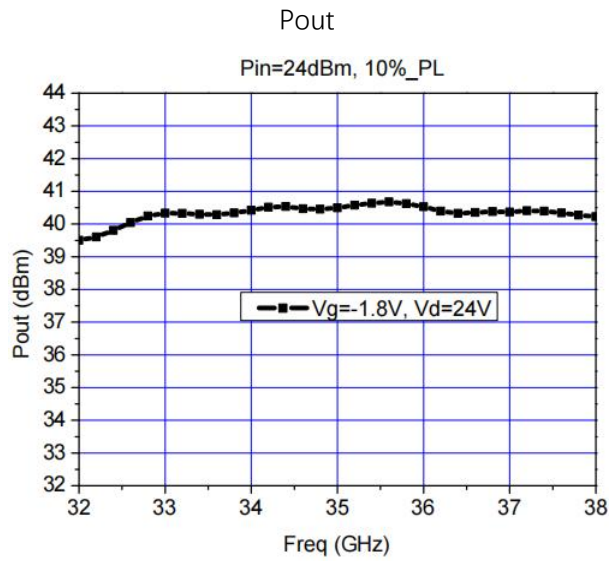



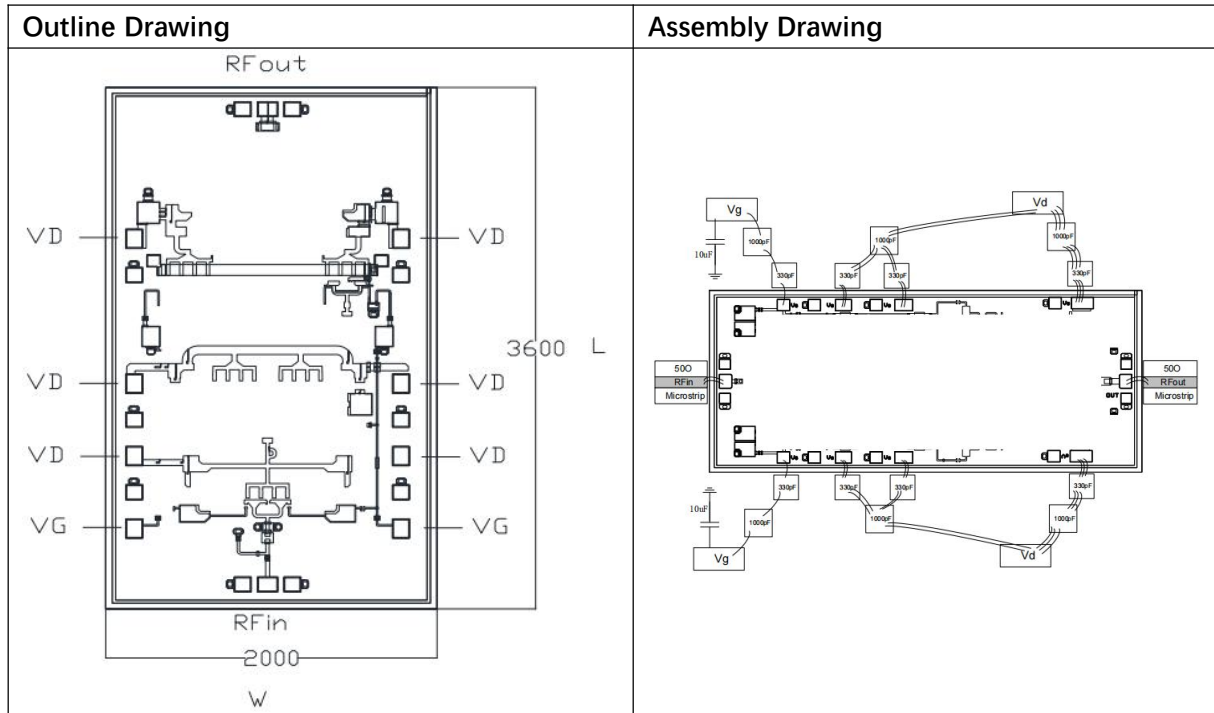

Absolute Max Ratings (TA=25°C)

Symbol	Parameter	Value	Remark
Vd	Drain Voltage	28V	
Id	Drain Current	2.5A	
Pd	DC Power	70W	
Pin	Input Power	32dBm	
Tch	Channel Temperature	225°C	
Tm	Mounting Temperature	300°C	1 min, N2 Protection
Tstg	Storage Temperature	-55~150°C	

Exceeding any one or combination of these limits may cause permanent damage.

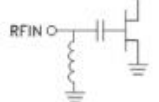

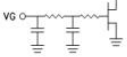
Pads Definition

Pad	Description	Equivalent Circuit
RFin	RF Signal input, connect to 50ohm system, block capacitor is needed if there's external DC applied on this pad.	
RFout	RF Signal output, connect to 50ohm system, no need block capacitor.	
VG	Amp gate bias, external 100pF, 1000pF capacitor is needed	
VD1、VD2、VD3	Amp drain bias, external 100pF, 1000pF capacitor is needed	
GND	Bottom must connect to RF and DC ground	