

Features

- High stability and reliability with good performance and no adjustment
- RoHS compatible
- Low amplitude ripple
- Low-loss RF SAW Filter
- Usable passband 12MHz
- Package size 1.4 mm *1. 1 mm

Electrical Specification

Temperature range for specification: T=-40°C to +85°C

Temperature source impedance: $Z_s=50 \Omega$

Temperature load impedance: $Z_L=50 \Omega$

ITEM		Min.	Typ.	Max.	Unit
Center Frequency		-	921	-	MHz
Insertion Loss	in 915-927 MHz	-	2.0	2.5	dB
Amplitude Variation	in 915-927 MHz		0.6	1.0	dB
Attenuation	0~895 MHz	40	50	-	dB
Attenuation	895~900 MHz	35	45	-	dB
Attenuation	945~950 MHz	35	45		dB
Attenuation	950~1200 MHz	40	50	--	dB
Attenuation	1200~3800 MHz	30	40		
VSWR	in 915-927 MHz	-	1.4	2.0	

Maximum Ratings

Rating	Symbol	Value	Unit
DC Voltage (between any Terminals)	V_{DC}	0	V
RF Power (in BW)	P	20dBm/55°C/5000h	
Operating Temperature Range	T_A	-40 ~ +85	°C
Storage Temperature Range	Tstg	-40 ~ +95	°C
ESD Voltage (HB)	V_{ESD}	> 150	V
Moisture Sensitivity Levels	MSL	2A	

Outline Drawing

Unit: mm

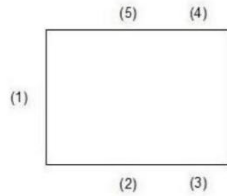

top view

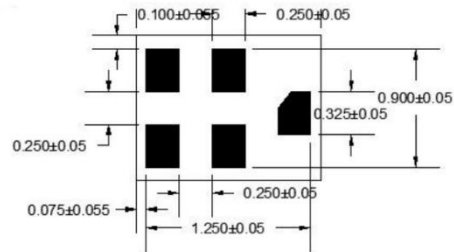

bottom view

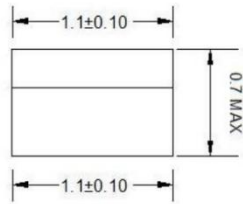

side view(left)

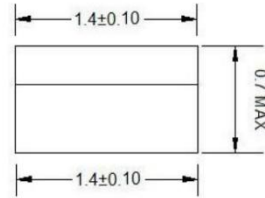

side view(front)

Pin Configuration

PIN#	Description
1	Input
4	Output
2,3,5	Ground



Marking

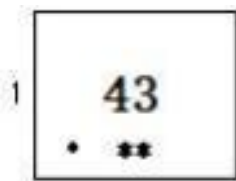

Top View, Laser Marking

“43”: Part Number

“.” Dot marking, indicates input

“1”: Terminal 1

The first “*”: Month Code (The code shown below varies in a 4-year-cycle)

Month	1	2	3	4	5	6	7	8	9	10	11	12
2016/2020	n	p	q	r	s	t	u	v	w	x	y	z
2017/2021	A	B	C	D	E	F	G	H	J	K	L	M
2018/2022	N	P	Q	R	S	T	U	V	W	X	Y	Z
2019/2023	a	b	c	d	e	f	g	h	i	j	k	m

The second “*”: Date Code

Date	1st	2nd	3rd	4th	5th	6th	7th	8th	9th	10th	
Code	A	B	C	D	E	F	G	H	J	K	
Date	11th	12th	13th	14th	15th	16th	17th	18th	19th	20th	
Code	L	M	N	P	Q	R	S	T	U	V	
Date	21st	22nd	23rd	24th	25th	26th	27th	28th	19th	30th	31st
Code	W	X	Y	Z	a	b	d	e	f	g	h

Typical Frequency Response

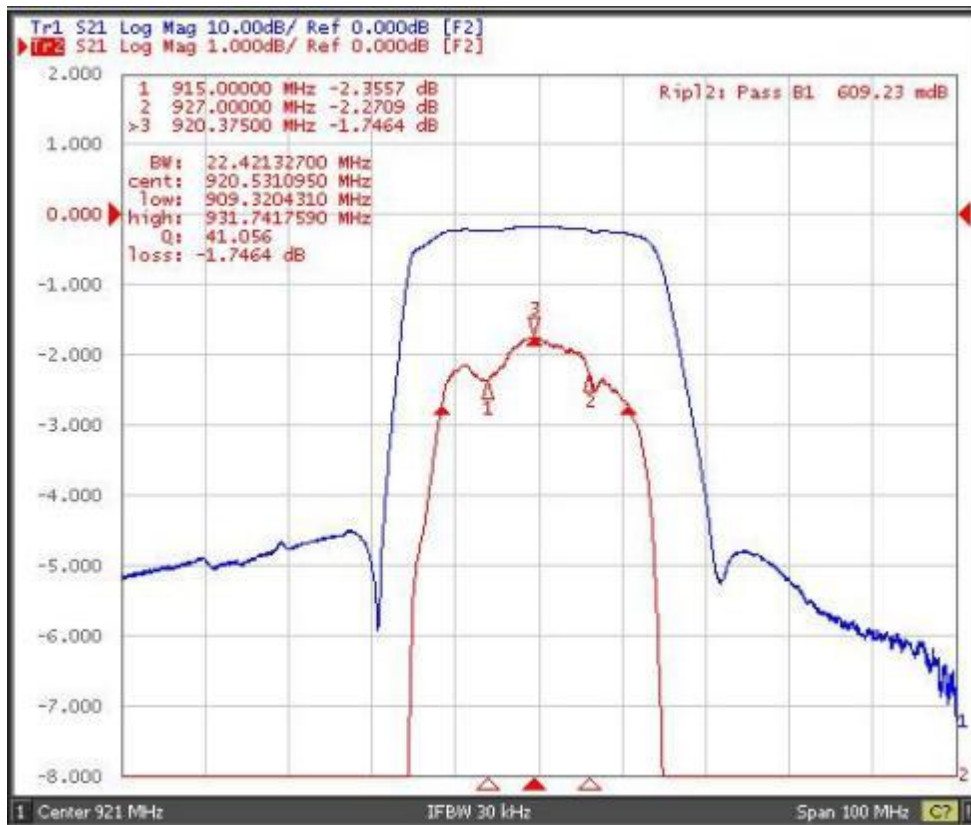

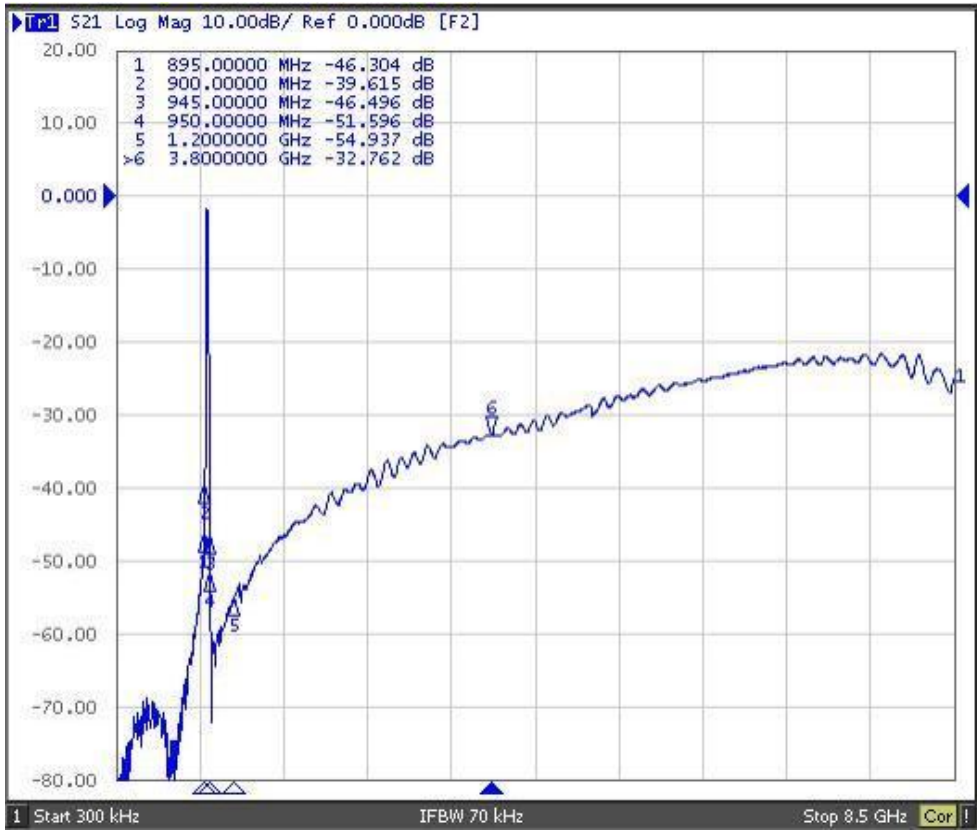
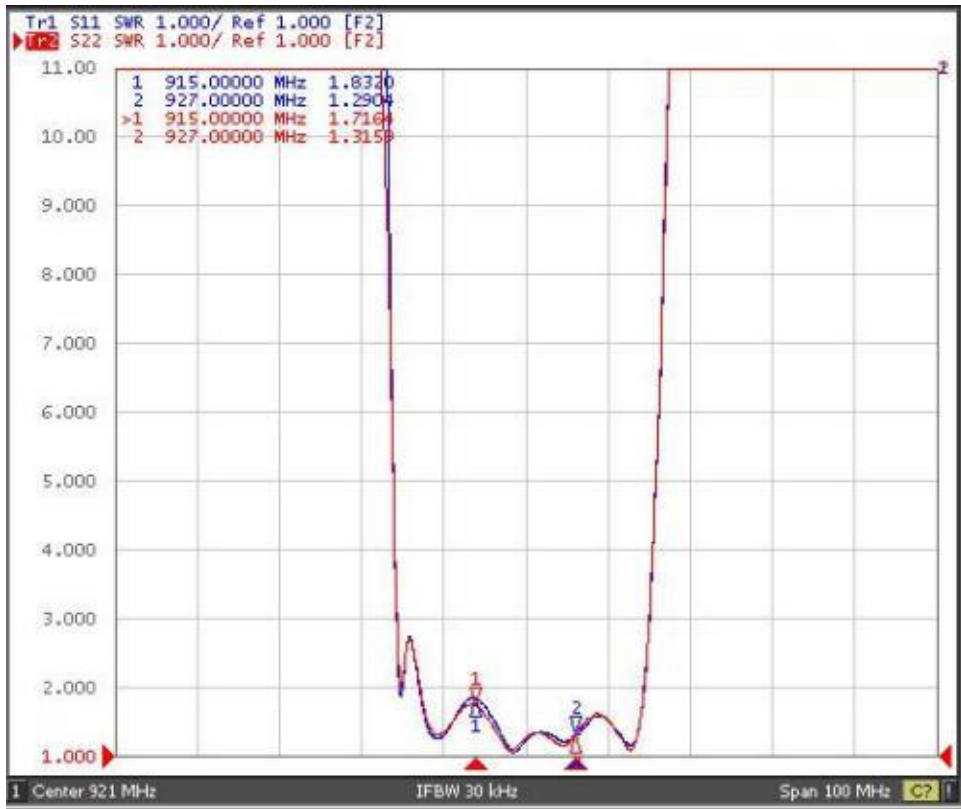

Test Circuit

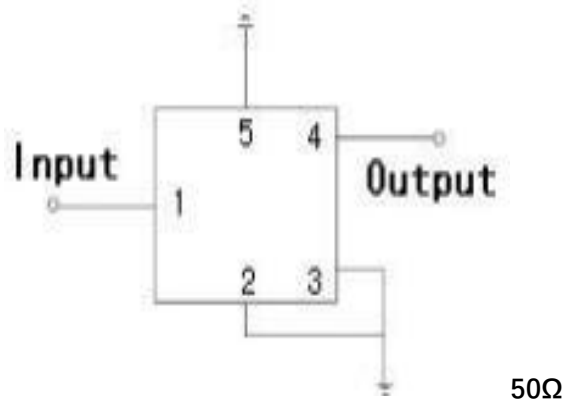

PCB Footprint

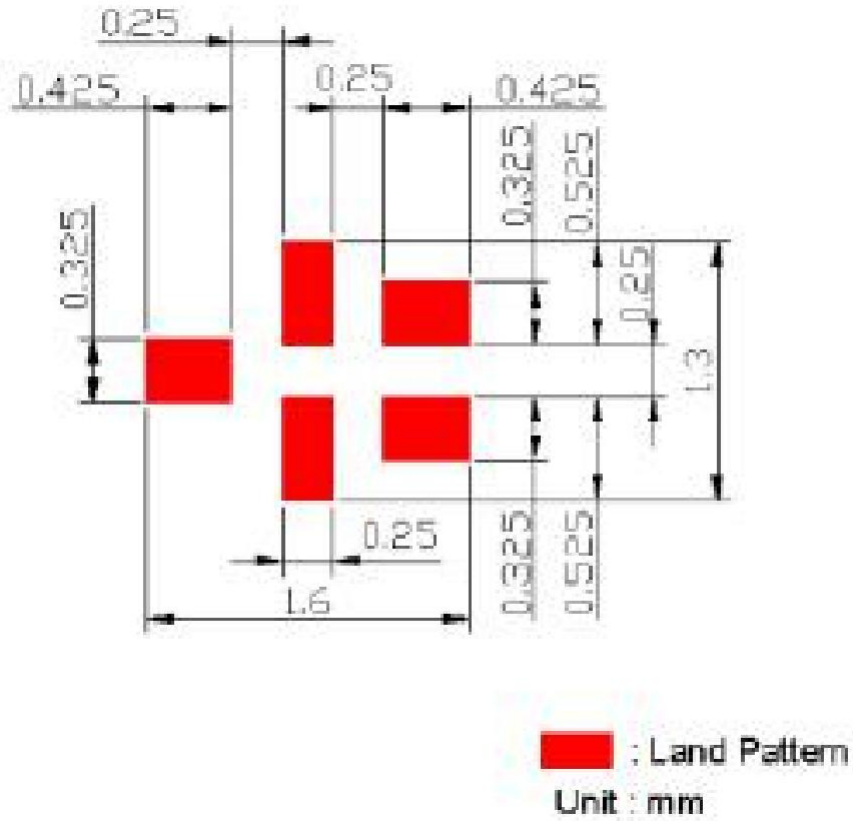

Stability Characteristics

ITEM	Test Item	STD Reference	Test Conditions	per lot
	Preconditioning	JESD22-A113	1) Temperature Cycling, 5 cycles -40°C to 85°C; 2) Bake, 24 hrs @85±5°C; 3)Moisture Soak, Soak time and conditions per IPC/JEDEC J-STD-020 based on device MSL level; 4) Reflow, 3 reflow cycles; 5) Drying, Room ambient temperature.	All behind
1	Temperature Cycling	JESD22-A104	-40°C / +85°C ,5°C/min, 15min dwell, < 1 min transfer time,500cycles	3*25 pcs
2	High Temperature Storage	JESD22-A103	Temperature = 85°C, 1000 hours.	3*25 pcs
3	Temperature Humidity no bias	JEDEC Std A101-B	85°C 85%RH 240 hours	3*25 pcs
4	Human Body Mode ESD	JESD22-A114	Ta=25°C, ≥100V	3 pcs
5	Charge Device Mode ESD	JESD22-C101	Ta=25°C, ≥100V	3 pcs
6	Solderability	JESD22-B102	Wetting: 245°C, 5s.	22 pcs
7	Drop Test	JESD22-B111	1500 Gs, 0.5 millisecond duration, half-sine pulse.	20 pcs
8	Mechanical Shock	JESD-47	Shock pulse of 1500g with pulse duration of 0.5+/-0. 1msec (X ,Y & Z); 5 shocks per axis.	3*25 pcs

Remarks

- SAW devices should not be used in any type of fluid such as water, oil, organic solvent, etc.
- Be certain not to apply voltage exceeding the rated voltage of components.
- Do not operate outside the recommended operating temperature range of components.
- Sudden change of temperature shall be avoided, deterioration of the characteristics can occur.
- Be careful of soldering temperature and duration of components when soldering.
- Do not place soldering iron on the body of components.
- Be careful not to subject the terminals or leads of components to excessive force.
- SAW devices are electrostatic sensitive. Please avoid static voltage during operation and storage.
- Ultrasonic cleaning shall be avoided. Ultrasonic vibration may cause destruction of components.

Packing Information

Carrier Tape

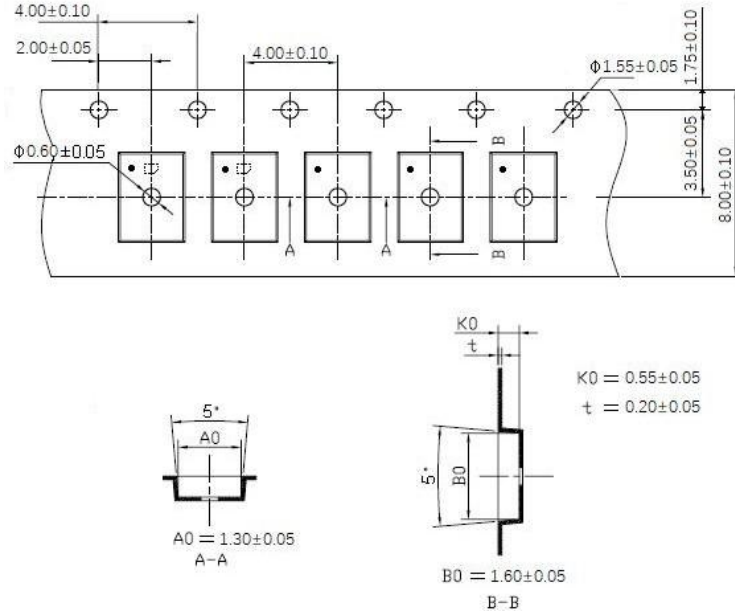

Reel Dimensions

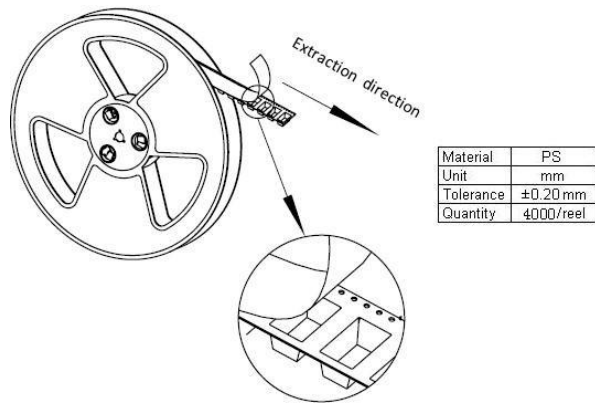

Outer Packing

Type	Quantity	Dimension	Description	Weight
Carton Box I	40000	240×210×285mm	anti-static plastic bag & carton box 1 reel / bag 10 bags / box (40000pcs)	1.86kg
Carton Box II	120000	470×310×285mm	30 bags / box (120000pcs)	5.64kg

Recommended Soldering Profile

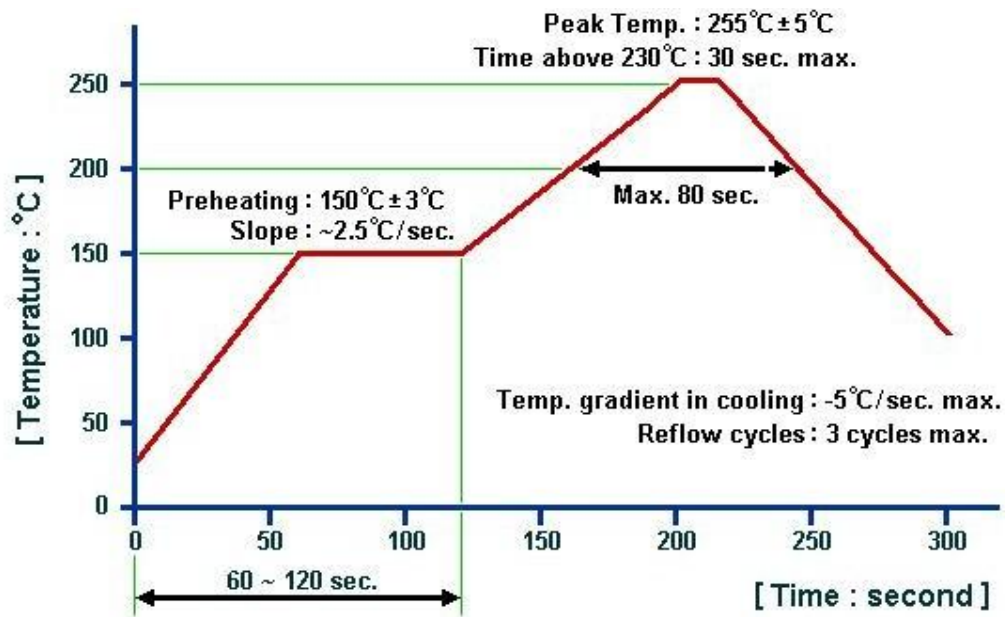

Remarks:

1. The specifications of this device are subject to change or obsolescence without notice.
2. Typically, equipment utilizing this device requires emissions testing and government approval, which is the responsibility of the equipment manufacturer.
3. Our liability is only assumed for the Surface Acoustic Wave (SAW) component(s) per se, not for applications, processes and circuits implemented within components or assemblies.
4. For questions on technology, prices and delivery, please contact our sales offices or e-mail sales@sainty-tech.com.