

Features

SAW filter for Single-ended wifi

- High stability and reliability with good performance
- Single ended to Single ended
- Narrow and sharp pass band characteristics. RoHS compatible
- Low insertion loss and deep stop band attenuation for interference
- Low – loss SAW filter for WIFI transmission
- Package size 1. 1mm*0.9mm

Electrical Specification

| ITEM | | Min. | Typ. | Max. | Unit |
|---------------------------------------|------------------|------|------|--------|------|
| Center Frequency | | | 2442 | | MHz |
| Insertion Loss | 2401~2483 MHz | | 1.5 | 2.5 *(| dB |
| Insertion Loss | 2401~2483 MHz | | 1.5 | 4.2 *) | |
| Insertion Loss | 2406~2478 MHz | | 1.5 | 1.9 *(| dB |
| Insertion Loss | 2406~2478 MHz | | 1.5 | 2.4*) | |
| Passband Ripple | 2401~2483 MHz | | 1.0 | 3.4 | dB |
| VSWR | 2401~2483 MHz | | 1.5 | 2.2 | |
| Attenuation | 10~1785MHz | 26 | 30 | | dB |
| Attenuation | 1805~1990 MHz | 25 | 30 | | dB |
| Attenuation | 2110~2367.5MHz | 27 | 30 | | dB |
| Attenuation | 2370.5~2377.5MHz | 6 | 20 | | dB |
| Attenuation | 2496~2501MHz | 5 | 15 | | dB |
| Attenuation | 2500~2505MHz | 14 | 44 | | dB |
| Attenuation | 2507.5~2687.5MHz | 28 | 32 | | dB |
| Attenuation | 2620~2690MHz | 27 | 32 | | dB |
| Attenuation | 2690~7000MHz | 20 | 31 | | dB |
| Input / Output Impedance (Nominal) | | 50 | | | Ω |

Maximum Ratings

| Rating | Symbol | Value | Unit |
|------------------------------------|-----------|--------------------------|------|
| DC Voltage (between any Terminals) | V_{DC} | 3 | V |
| RF Power (in BW) | P | +25 dBm 5000 h +50 deg.C | |
| Operating Temperature Range | T_A | -30 ~ +85 | °C |
| Storage Temperature Range | Tstg | -40 ~ +85 | °C |
| ESD Voltage (HB) | V_{ESD} | >150 | V |
| Moisture Sensitivity Levels | MSL | 3 | |

Outline Drawing

Unit: mm

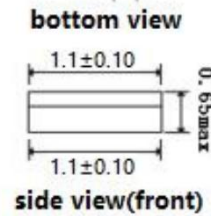
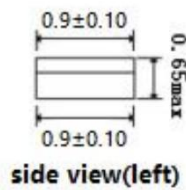
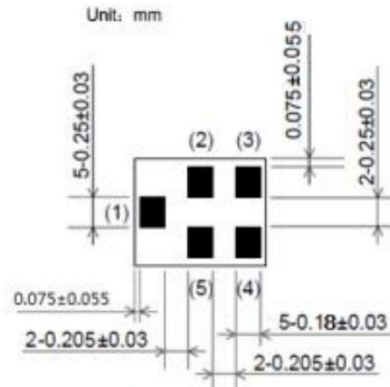
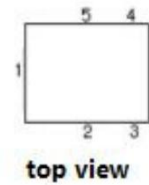

Pin Configuration

| PIN# | Description |
|-------|-------------|
| 1 | Input |
| 4 | Output |
| 2,3,5 | Ground |



Marking

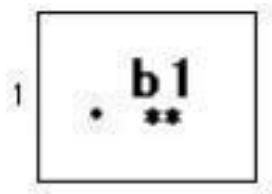

Top View, Laser Marking

“b1”: Part Number
 “.” Dot marking, indicates input
 “1”: Terminal 1

The first “*”: Month Code (The code shown below varies in a 4-year-cycle)

| Month | 1 | 2 | 3 | 4 | 5 | 6 | 7 | 8 | 9 | 10 | 11 | 12 |
|-----------|---|---|---|---|---|---|---|---|---|----|----|----|
| 2016/2020 | n | p | q | r | s | t | u | v | w | x | y | z |
| 2017/2021 | A | B | C | D | E | F | G | H | J | K | L | M |
| 2018/2022 | N | P | Q | R | S | T | U | V | W | X | Y | Z |
| 2019/2023 | a | b | c | d | e | f | g | h | i | j | k | m |

The second “*”: Date Code

| | | | | | | | | | | | |
|------|------|------|------|------|------|------|------|------|------|------|------|
| Date | 1st | 2nd | 3rd | 4th | 5th | 6th | 7th | 8th | 9th | 10th | |
| Code | A | B | C | D | E | F | G | H | J | K | |
| Date | 11th | 12th | 13th | 14th | 15th | 16th | 17th | 18th | 19th | 20th | |
| Code | L | M | N | P | Q | R | S | T | U | V | |
| Date | 21st | 22nd | 23rd | 24th | 25th | 26th | 27th | 28th | 19th | 30th | 31st |
| Code | W | X | Y | Z | a | b | d | e | f | g | h |

Typical Frequency Response

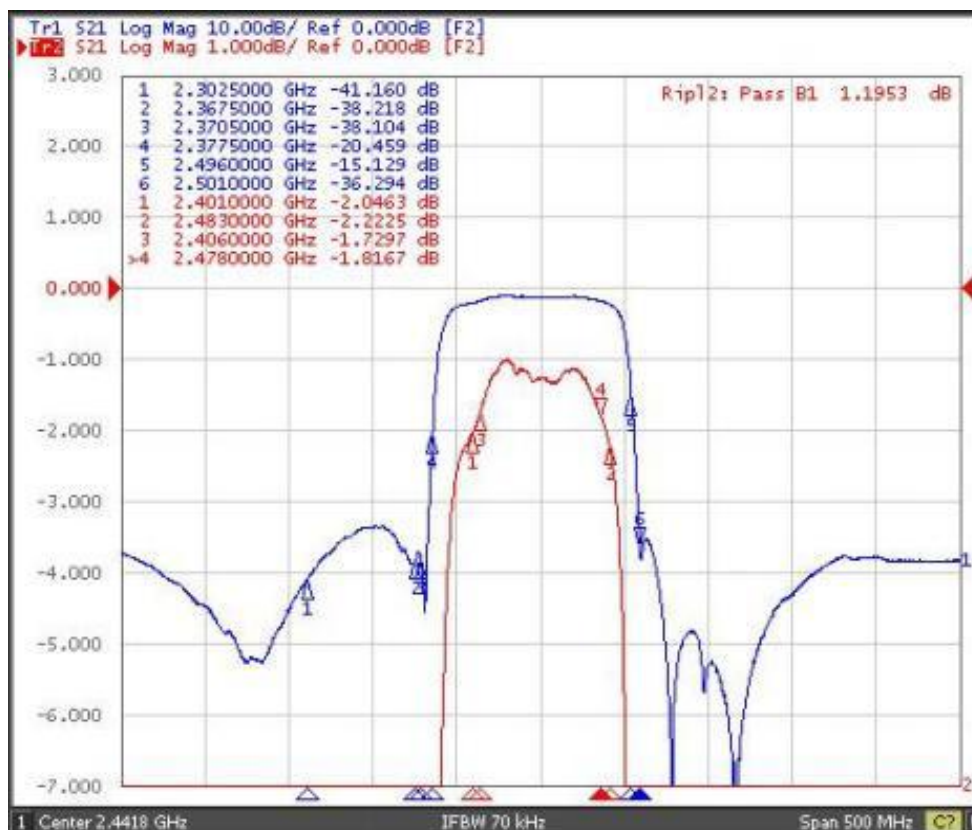

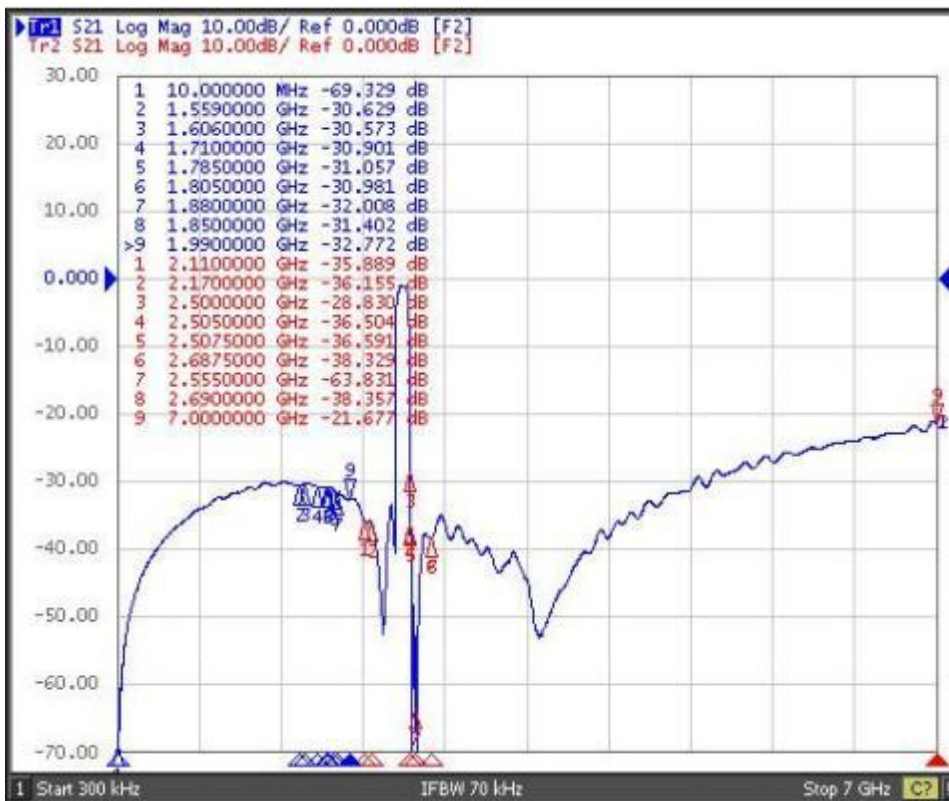
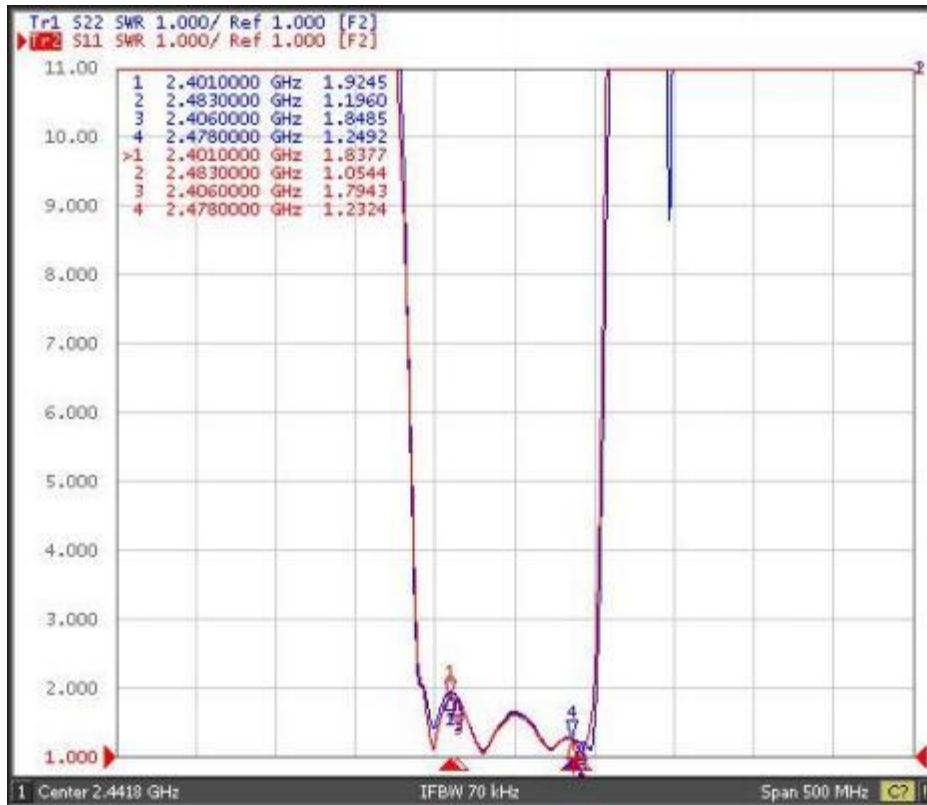

Test Circuit

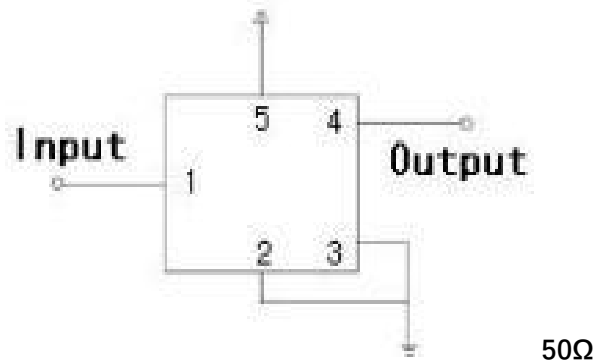

Stability Characteristics

| ITEM | Test Item | STD Reference | Test Conditions | per lot |
|------|------------------------------|------------------|--|------------|
| | Preconditioning | JESD22-A113 | 1) Temperature Cycling, 5 cycles -40°C to 85°C; 2) Bake, 24 hrs @85±5°C; 3)Moisture Soak, Soak time and conditions per IPC/JEDEC J-STD-020 based on device MSL level; 4) Reflow, 3 reflow cycles; 5) Drying, Room ambient temperature. | All behind |
| 1 | Temperature Cycling | JESD22-A104 | -40°C / +85°C ,5°C/min, 15min dwell, < 1 min transfer time,500cycles | 3*25 pcs |
| 2 | High Temperature Storage | JESD22-A103 | Temperature = 85°C, 1000 hours. | 3*25 pcs |
| 3 | Temperature Humidity no bias | JEDEC Std A101-B | 85°C 85%RH 240 hours | 3*25 pcs |
| 4 | Human Body Mode ESD | JESD22-A114 | Ta=25°C, ≥100V | 3 pcs |
| 5 | Charge Device Mode ESD | JESD22-C101 | Ta=25°C, ≥100V | 3 pcs |
| 6 | Solderability | JESD22-B102 | Wetting: 245°C, 5s. | 22 pcs |
| 7 | Drop Test | JESD22-B111 | 1500 Gs, 0.5 millisecond duration, half-sine pulse. | 20 pcs |
| 8 | Mechanical Shock | JESD-47 | Shock pulse of 1500g with pulse duration of 0.5+/-0. 1msec (X ,Y & Z); 5 shocks per axis. | 3*25 pcs |

Remarks

- SAW devices should not be used in any type of fluid such as water, oil, organic solvent, etc.
- Be certain not to apply voltage exceeding the rated voltage of components.
- Do not operate outside the recommended operating temperature range of components.
- Sudden change of temperature shall be avoided, deterioration of the characteristics can occur.
- Be careful of soldering temperature and duration of components when soldering.
- Do not place soldering iron on the body of components.
- Be careful not to subject the terminals or leads of components to excessive force.
- SAW devices are electrostatic sensitive. Please avoid static voltage during operation and storage.
- Ultrasonic cleaning shall be avoided. Ultrasonic vibration may cause destruction of components.

Packing Information

Carrier Tape

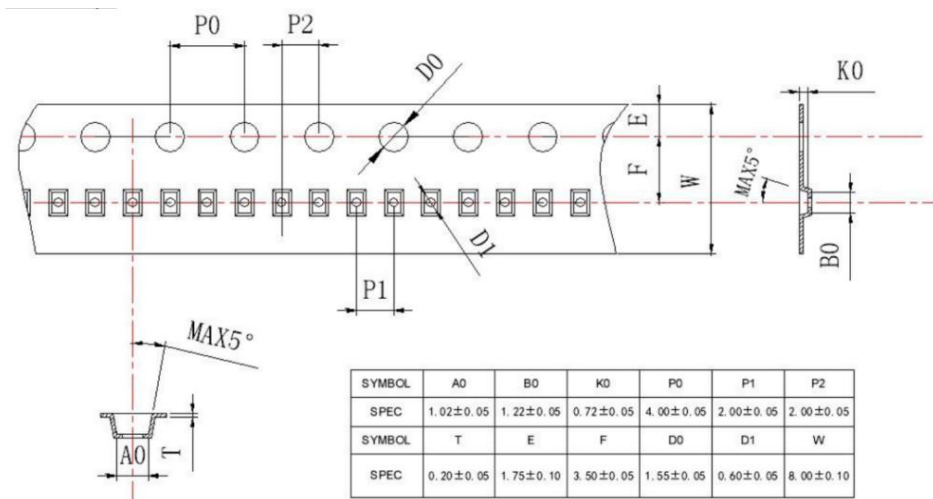

Reel Dimensions

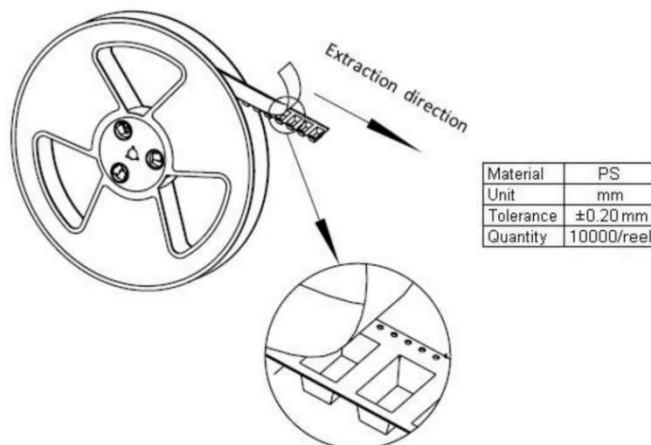

Outer Packing

| Type | Quantity | Dimension | Description | Weight |
|---------------|----------|---------------|--|---------------------------|
| Carton Box I | 100000 | 240×210×285mm | anti-static plastic bag & carton box 1 reel / bag 10 bags / box (100000pcs) | 2.15kg |
| Carton Box II | 300000 | 470×310×285mm | | 30 bags / box (300000pcs) |

Recommended Soldering Profile

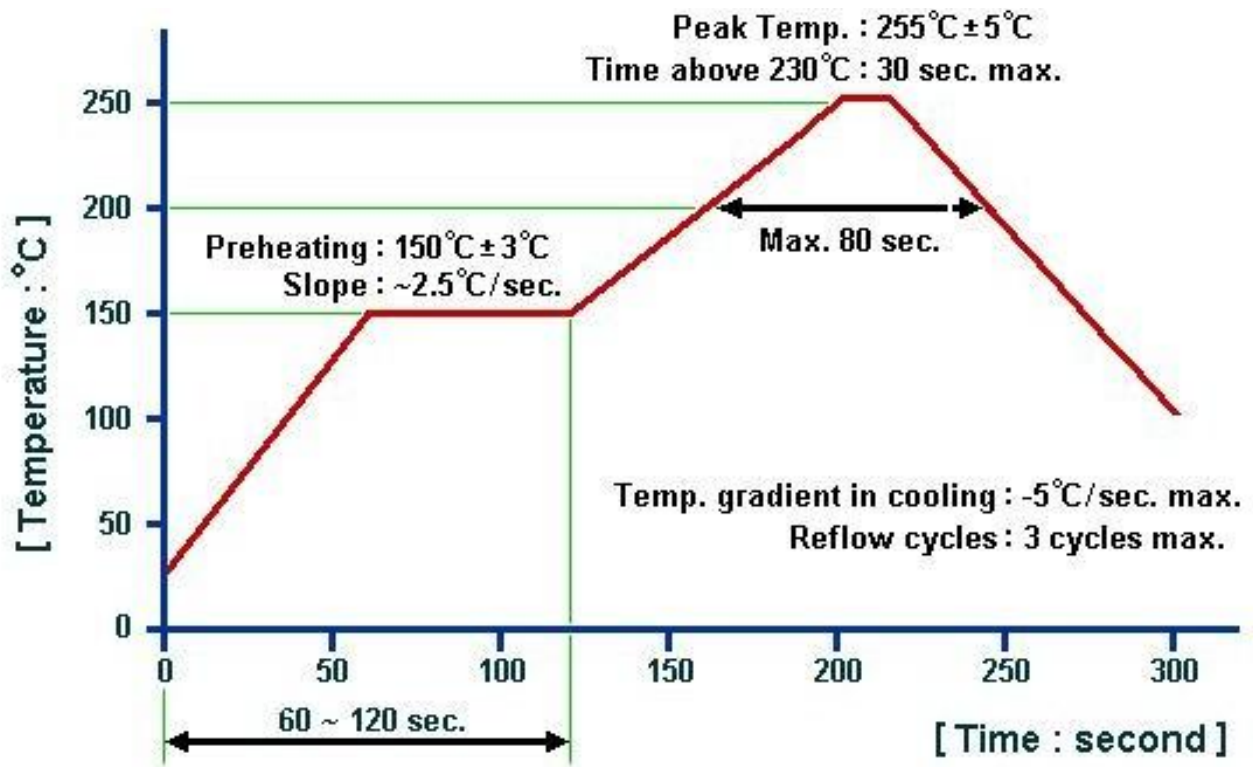

Remarks:

1. The specifications of this device are subject to change or obsolescence without notice.
2. Typically, equipment utilizing this device requires emissions testing and government approval, which is the responsibility of the equipment manufacturer.
3. Our liability is only assumed for the Surface Acoustic Wave (SAW) component(s) per se, not for applications, processes and circuits implemented within components or assemblies.
4. For questions on technology, prices and delivery, please contact our sales offices or e-mail sales@sainty-tech.com.