

Features

- Wide Band
- Low Insertion Loss
- High Directivity
- Stable Performance
- Customization Available Upon Request

Applications

- Radar Systems
- Communication Systems
- Receivers Systems



Electrical Specifications (TA=25°C)

Parameter	Min.	Typ.	Max.	Unit
Frequency		1-8		GHz
Insertion Loss			0.6	dB
Normal Coupling		30		dB
Coupling Accuracy			±1.0	dB
Frequency Sensitivity			±1.0	dB
Directivity	20			dB
VSWR			1.2	-
Power Handling		50		W
Impedance		50		Ω
Input / Output Connectors	SMA-Female			
Material	Aluminum			
Weight	-g			
Package Sealing	Black Color (Standard)			

Environmental Specifications

Operating Temperature	-45 to +85°C
Storage Temperature	-55 to +125°C

Outline Drawing

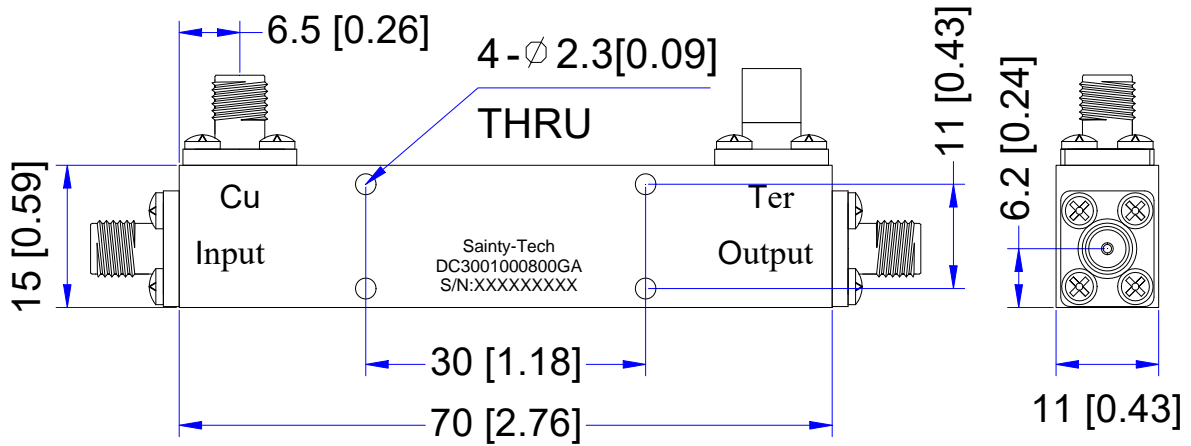

Unit: mm [inches]

Outline Tolerance: ± 0.25 [0.01]

Note

1. The product is designed to meet environmental ratings but not tested. If you need to test environmental condition, please contact our sales department.
2. Sainty-Tech Communications Limited reserves the right to change the above information without notice.