

### Features

- Ultra Wide Band
- Low Insertion Loss
- High Directivity
- Stable Performance
- Customization Available Upon Request

### Applications

- Radar Systems
- Communication Systems
- Receivers Systems



### Electrical Specifications (TA=25°C)

Parameter	Min.	Typ.	Max.	Unit
Frequency		1-40		GHz
Insertion Loss		1.4	1.7	dB
Normal Coupling		20		dB
Coupling Accuracy		±0.3	±1.0	dB
Frequency Sensitivity		±0.9	±1.2	dB
Directivity	10	14		dB
VSWR		1.6	1.7	-
Power Handling		20		W
Impedance		50		Ω
Input / Output Connectors	2.92mm-Female			
Material	Aluminum			
Weight	45.4 g / 1.6 Ounces Max.			
Package Sealing	Black Color (Standard)			

### Environmental Specifications

Operating Temperature	-55 to +85°C
Storage Temperature	-55 to +100°C



Test Curves

IN-Port VSWR

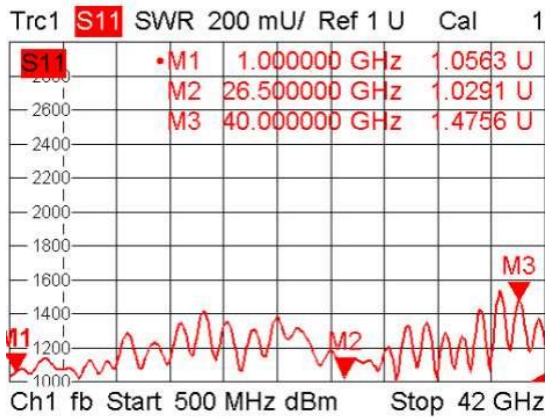

OUT-Port VSWR

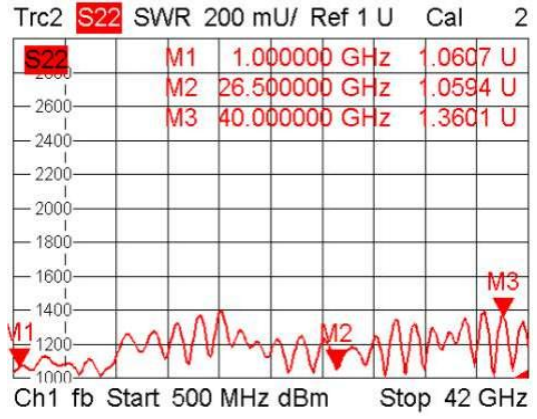

Coupling-Port VSWR

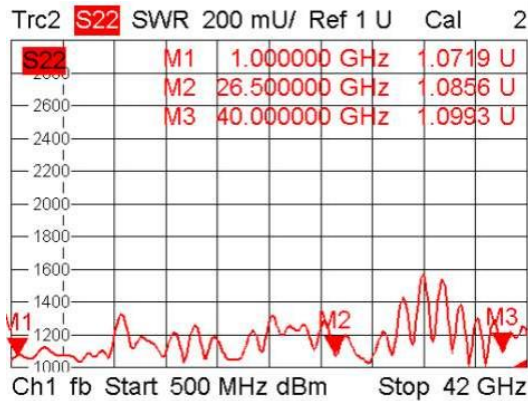

Insertion Loss

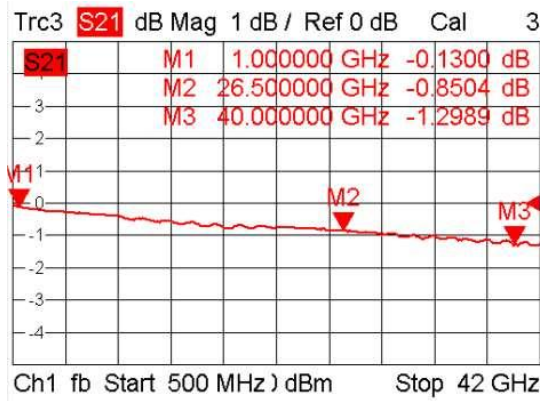

Coupling

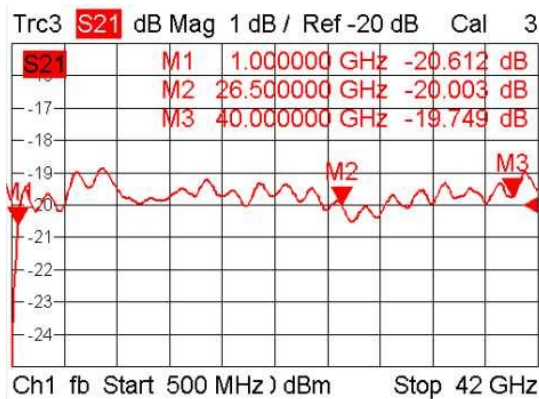

Directivity

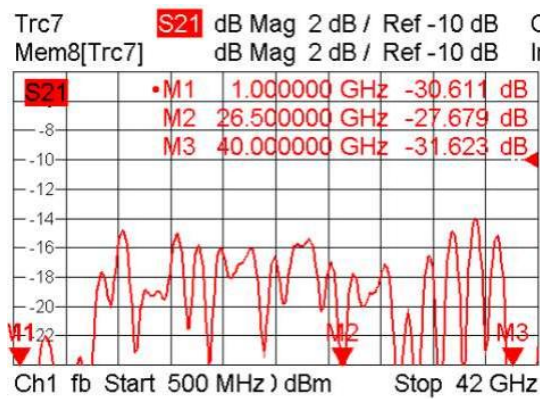

### Outline Drawing

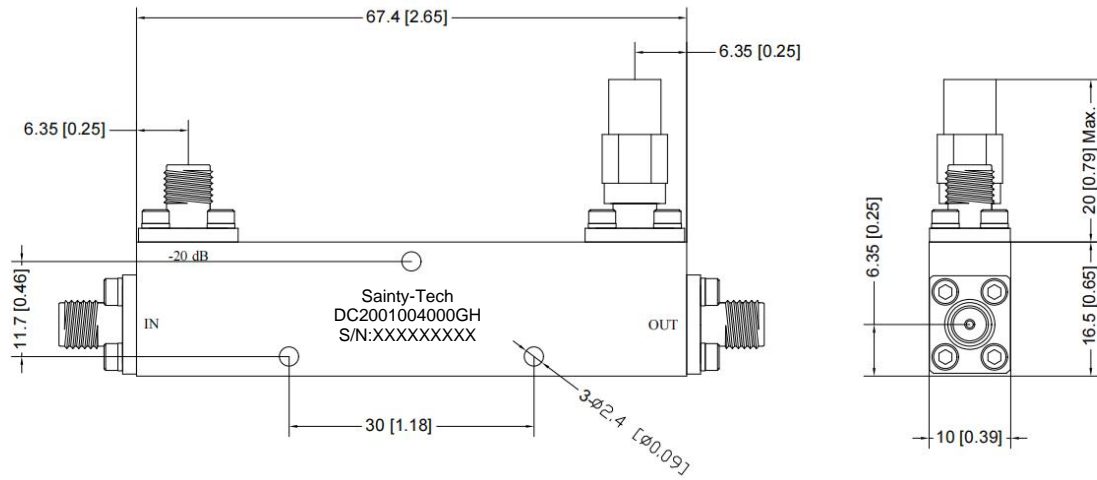

Unit: mm [inches]

Outline Tolerance:  $\pm 0.25$ [0.01]

### Note

1. The product is designed to meet environmental ratings but not tested. If you need to test environmental condition, please contact our sales department.
2. Sainty-Tech Communications Limited reserves the right to change the above information without notice.